

DRAWING MADE IN THIRD ANGLE PROJECTION
 THIS DRAWING IS UNPUBLISHED. RELEASED FOR PUBLICATION
 © COPYRIGHT 1980 BY AMP INCORPORATED. ALL INDUSTRIAL RIGHTS RESERVED.

REV. NO.		DATE		DESCRIPTION	
CM	53	0	6-7-91	0	RELEASED PER PR CH 91-69

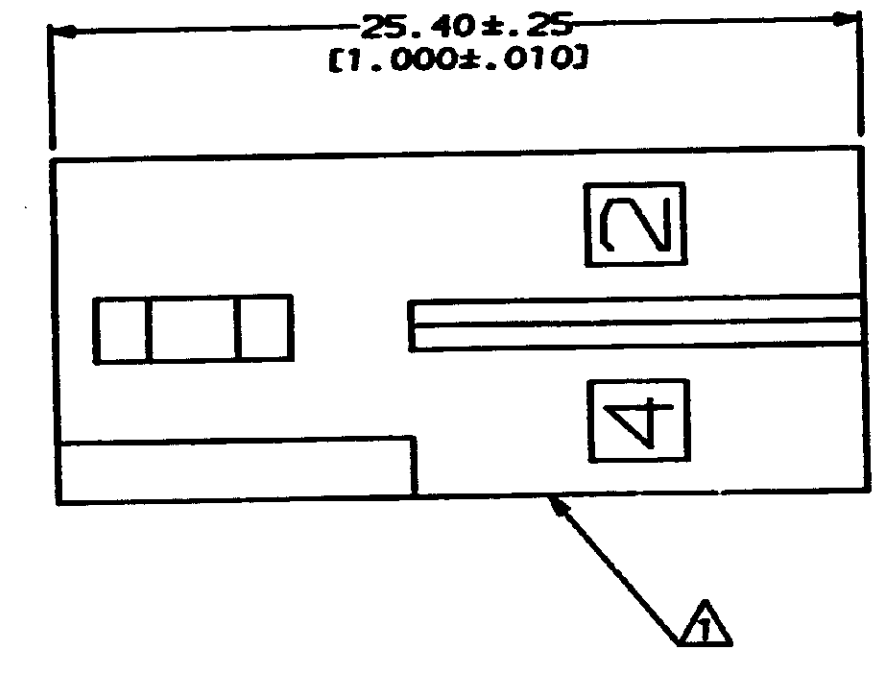

△ AMP LOGO LOCATED THIS SURFACE.
 2. DIMENSIONS IN BRACKETS ARE IN INCHES.

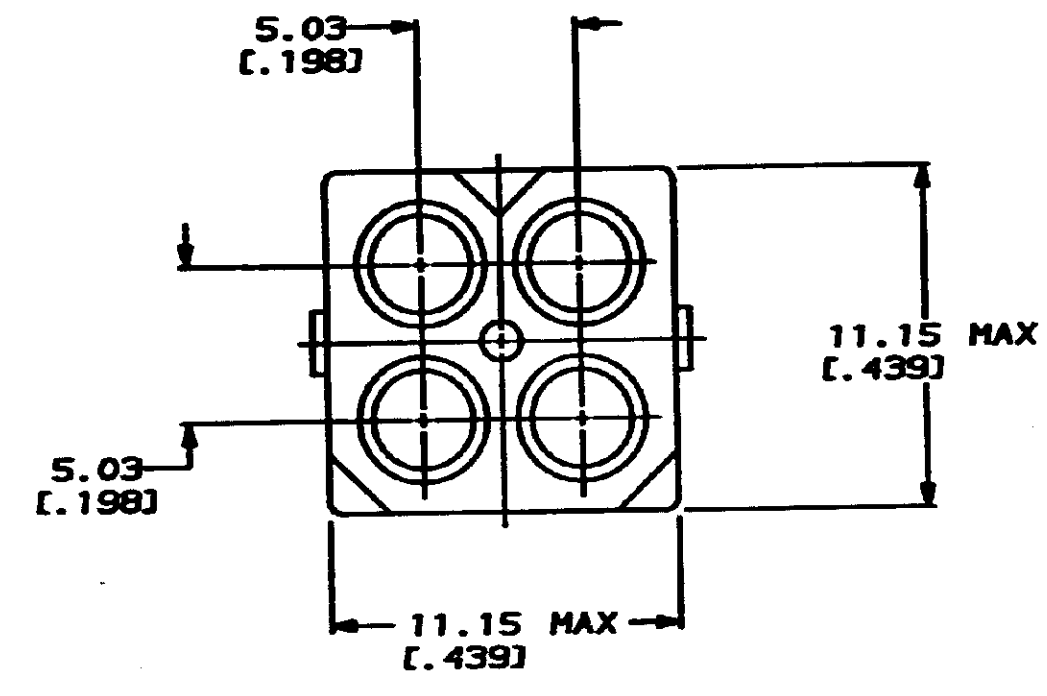
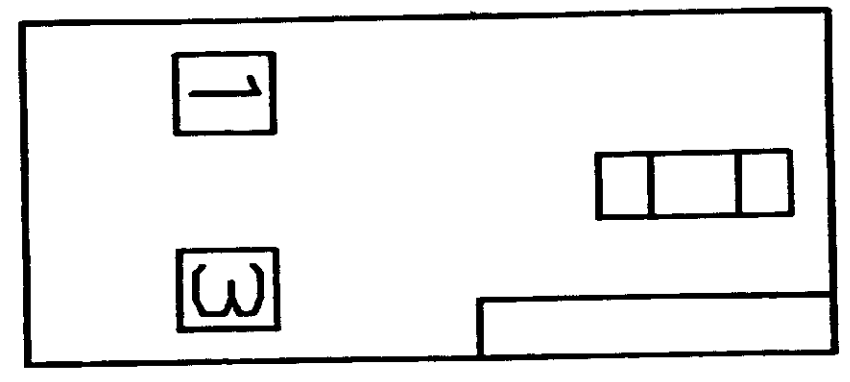
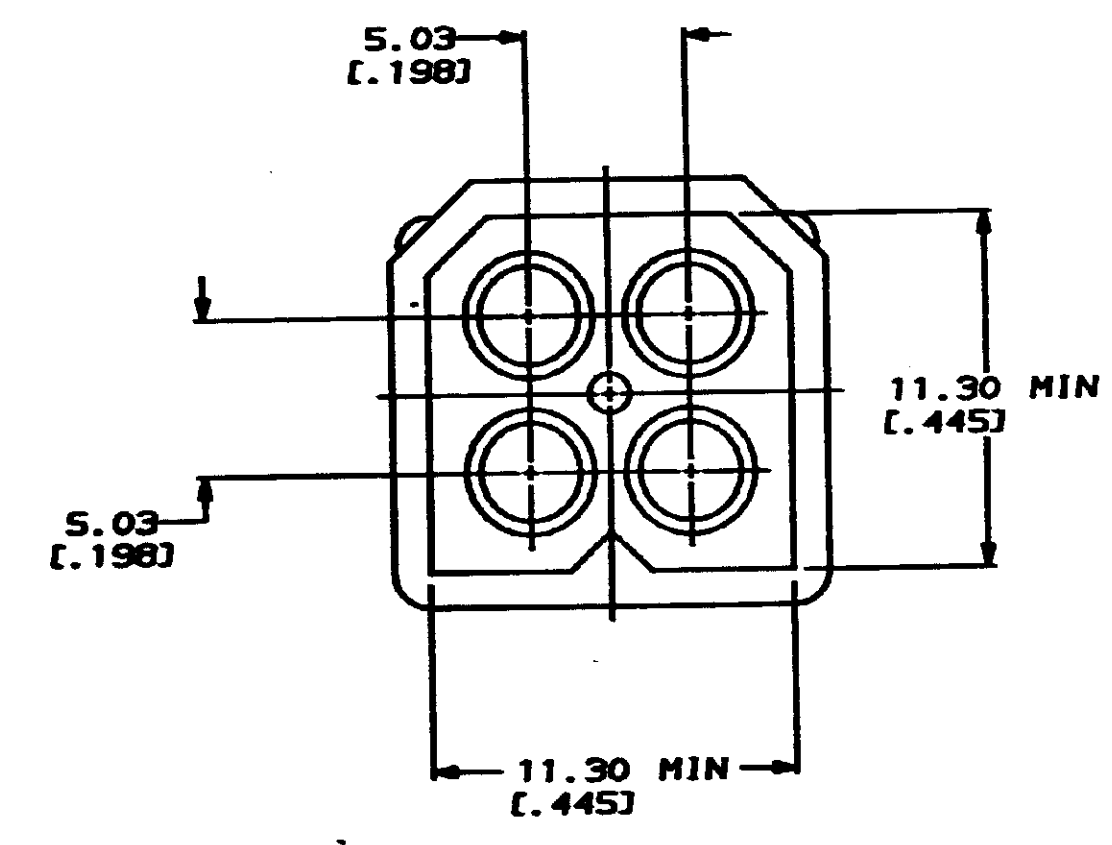

MATING CONNECTOR INTERFACE

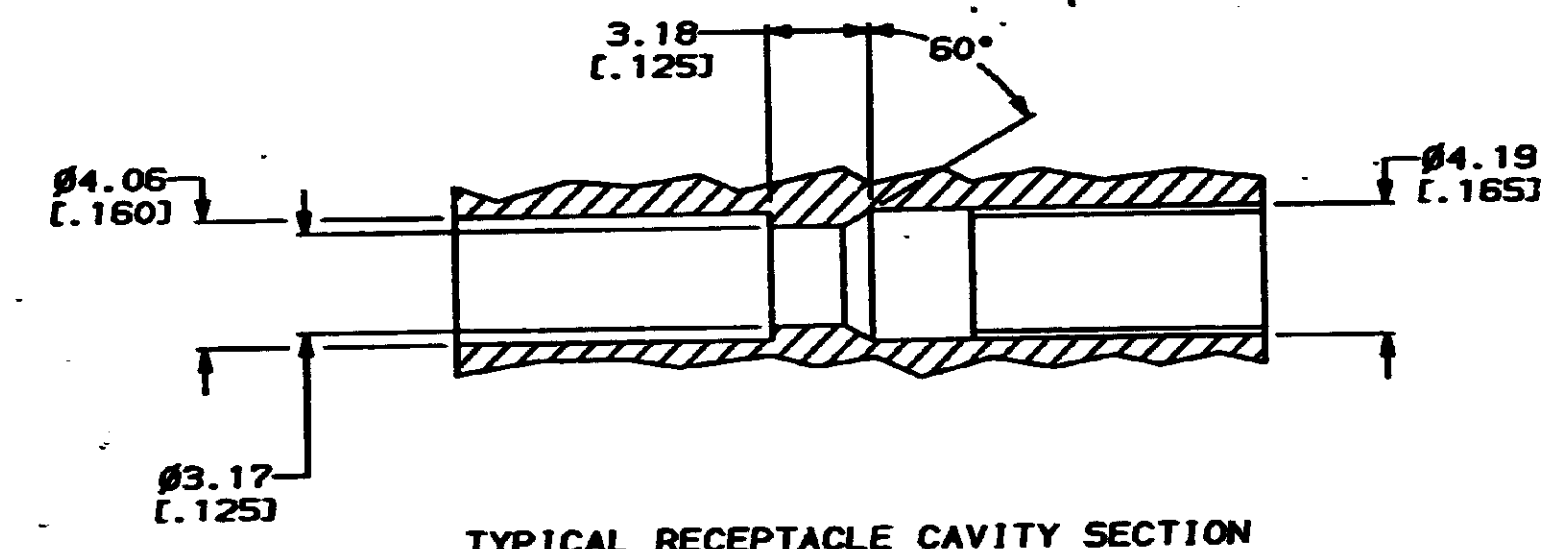

TYPICAL RECEPTACLE CAVITY SECTION
 (DIMENSIONS REFERENCE ONLY)

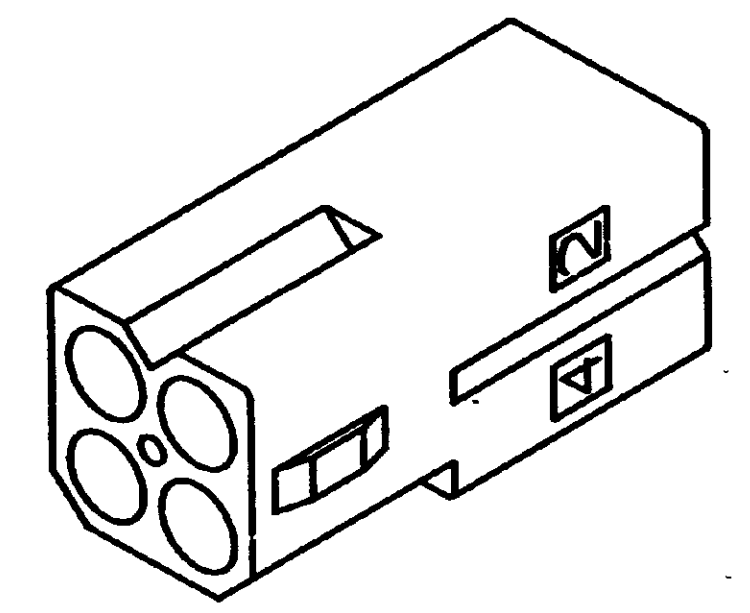

3-DIMENSIONAL MODEL
 NTS

METRIC

770843-1 PART NO		AMP Incorporated Harrisburg, PA 17105-3608	
DO NOT SCALE PRINT. UNLESS SPECIFIED DIMENSIONS IN mm (INCHES) TOLERANCES ON: 2 PLC DEC ± . 3 PLC DEC ± 0.13 (.005) ANGLES ± 1°-0'		NAME RECEPTACLE, 4 CIRCUIT, .093 PIN AND SOCKET	
MATERIAL NYLON, UL 94V-2 NATURAL		SIZE D 00779	DRAWING NO 770843
FINISH		SCALE 5:1	SHEET 1 OF 1

CUSTOMER DRAWING